



GÖÇMAKSAN®

The power is in your hand

**MG20B 220V DIGITAL
MG20B 220V MANUAL
MG20B 380V DIGITAL
MG20B 380V MANUAL
PORTABLE STIRRUP BENDING MACHINE USER'S AND
MAINTENANCE MANUAL**

MG20B/D USER MANUAL VIDEO : <https://www.youtube.com/watch?v=qg05mD5T-fQ&t=138s>



444 6 467
444 6 GMS

info@gocmaksan.com



CONTENTS

INTRODUCTION **Hata! Yer işareti tanımlanmamış.**

1.MAIN PARTS OF REBAR BENDING MACHINE1

2.MACHINE ASSEMBLY1

3.MACHINE RUNNING PROCEDURES ORDER1

3.1. Energise and Rotation Determining of the Direction of Rotation1

3.2. Operation of 380V Manual Machine.....1

3.3. Operation of 220V Manual Machine.....1

3.4.Operation of 380V Digital Machine.....2

3.5. Operation of 220V Digital Machine.....2

4.TECHNICAL DATA3

5. EQUIPMENT SUPPLIED WITH MACHINE3

6. OPERATION OF MACHINE.....3

6.1. Correct Positioning of Rebar On The Machine.....3

6.2. Incorrect Positioning of Rebar On The Machine.....3

7. PROHIBITED USAGE ON THE MACHINE4

8. SCOPE OF WARRANTY4

9. PROTECTORS TO BE USED WHEN WORKING WITH THE MACHINE4

9.1.Protector Apparel.....4

9.2.Work Clothes4

10.HANDLING THE MACHINE4

11. CONTROLS AND SETTINGS ON THE MACHINE.....5

11.1 Thermal current adjustment field setting and engine protection switch.....5

11.2.Hook Bending (P3).....5

11.3.Set-Square Bending (P2).....5

11.4. Bent-Bar Bending (P1).....6

11.5. Stirrup Bending.....6

12.MAINTENANCE AND LUBRICATION INSTRUCTIONS.....6

13.SAFETY.....7



Important Warning !!!

- The maintenance and user’s manuals should certainly be read.
- Just the persons, who are adequately informed on it, should work with the machine.
- While the machine is checked, maintained, lubricated, etc., the power of the machine should be cut off.
- All instructions in the maintenance and user’s manual should be observed.

1. MAIN PARTS OF REBAR BENDING MACHINE

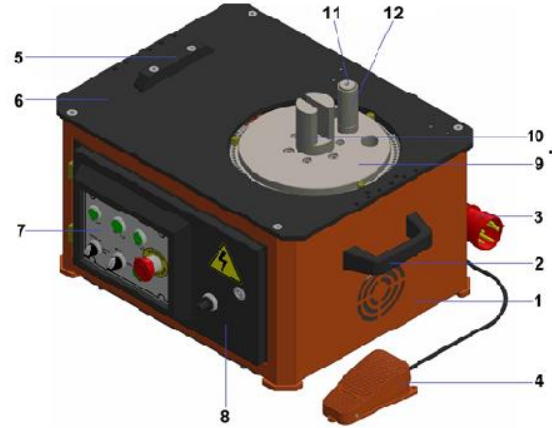

Figure 1: Main Sections Of Rebar bending Machine

1	Machine Chasis	4	Foot Pedal	7	Control Panel	10	Stirrup Head
2	Holding Handle	5	Rebar Sliding Lama	8	Electric Panel	11	Straight Pin
3	Energy Plug	6	Upper Table	9	Bending Disc	12	Bending Sleeve

2. MACHINE ASSEMBLY

- Machine should be leveled on a solid ground.**Figure 2**

Electricity connection of the machine should be made by competent technicians

Electricity Connection

- For main electricity connection plug should be connected to supply line with a 5x2,5 mm² isolated cable and then plugged into power outlet. (maximum 25 mt.)
- Grounding connection should be made for safety. Machine shouldn't be operated without making grounding connection.



Connection of grounding line

The following procedures should be followed for this system Connect one end of the grounding to a copper wire (minimum 16 mm²) as it will enable electrical conductivity. The other end should be either connected with a pipe that has a conductivity capacity immersed into the ground (preferably into a humid

INTRODUCTION

MG20B Portable Rebar bending machine is only intended for bending the rebar. The utilization of it for all purposes is prohibited, except this purpose.

In order to operate your machine better, the machine should be placed so as to be operated easily and in the position which allows operator to work more productively. For this reason, the place, where the machine is operated, should be close to the area where the rebar is kept. In addition to it, it will be useful that the roof of the place, where the machine operates, is covered with shed. We recommend you to place the workbenches in the both sides of machine. The length of those workbenches should be at the longest length of rebar which will be bent. Since the operator may work easily by those benches without rotation, lifting all rebar, it shall allow operator to work more productively.

ground) or the copper plate should be buried into the ground as much as deep

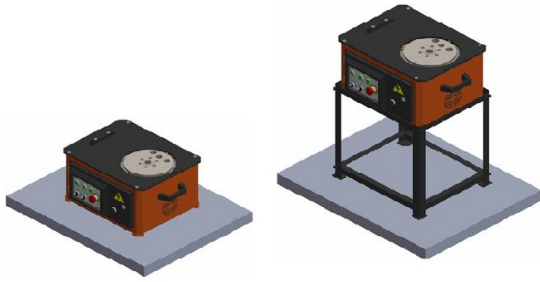

Figure 1: Leveling the machine on a solid ground

3. MACHINE RUNNING PROCEDURES ORDER

3.1. Energise and Rotation Determining of the Direction of Rotation

Ensure that the machine is settled up properly according to assembling rules.

Empty the bending Tools on the machine before starting to bend. Start the machine by Plugging it to the energy (Figure:1 No:3) and open the electric panel cover (Figure:1 No:8) and switch the main switch (Figure:3 No:14) from “0” to “1” . on digital models, switch “ON-OFF” button to “ON” position on the control panel.

Ensure that the power lamp on manual models and control pabel lamps on the digital models are lighting after the machine is started.

Determine the direction of the rotation by switching the MAN-AUTO button to MAN position on the control panel and by pressing the foot pedal. (Figure:1 No:4)

Take the front side of the machine as Reference, and the clockwise rotation of bending disc on Figure:1 No:9 should be right and counter clockwise rotation should be left. Manufacturer recommends the right side bending. If the bending disc is turning to left side, the phases coming from the main electric network should be reverse. This situation does not affect the working system of the machine. In case of facing the same, if the machine is a digital model, change the LEFT-RIGHT position from the control panel or if it is manual model, change the direction of phases by an experienced electrician. Start to the bending adjustments after determining the direction of rotation.



Figure 2: Determining the Direction of Rotation

13	Switch Pin	14	Main Switch
----	------------	----	-------------

3.2. Operation of 380V Manual Machine:

- Place the suitable stirrup head for your rebar, the straight pin and the bending sleeve (Figure:1 No:10,11,12) to the related holes of the bending discs.
- Locate the switch pins on the small holes around the bending disc to adjust the bending angle . (Figure:3 No:13)
- Select the bending shape from the buttons on the control panel. (Figure:4 No:16,17,18)
- On stirrup bendings, switch the PROG. ON-OFF button to (Figure4: No:19) “ON” position and max. 9 different bending is adjusted at once and the bending can be done in the adjusted order.
- After the adjustment is finished, switch the MAN-AUTO button(Figure:4 No:20) to AUTO position and start to serial bending.
- In case of an emergency, machine can be stopped by pressing the ‘emergency stop button2 on the control panel. (Figure:4 No:22) When you start to bend machine will re-start from the latest adjusted programme.

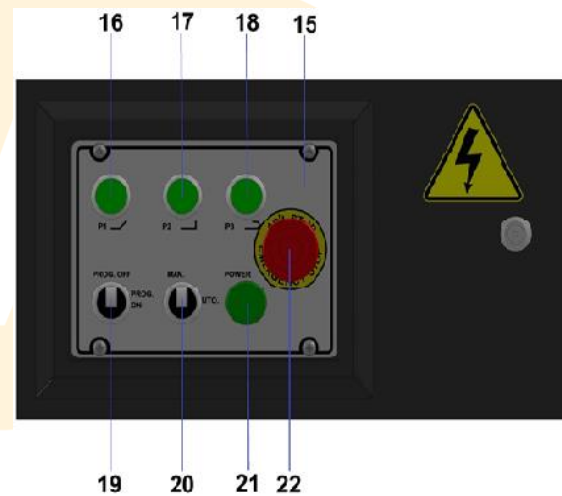

Figure 4: 380V Manual Machine Control Buttons

15	Control Panel	17	P2 Button	19	Prog.On-Off	21	Power Lamp
16	P1 Button	18	P3 Button	20	Man-Auto Button	22	Emergency Stop

3.3. Operation of 220V Manual Machine:

- Place the suitable stirrup head for your rebar, the straight pin and the bending sleeve (Figure:1 No:10,11,12) to the related holes of the bending discs.
- Locate the switch pins on the small holes around the bending disc to adjust the bending angle . (Figure:3 No:13)
- Select the bending shape from the buttons on the control panel. (Figure:5 No:24,25,26)
- Adjust the machine’s speed by the Speed Controller (Figure:5 No:31) Once the speed of the machine decreased, the bending disc’s rotation speed will reduce and machine’s power (bending capacity) will increase. And when the speed is increased the bending disc’s rotation speed will increase and the machine’s power (bending capacity) will decrease.
- As soon as the speed decreases the bending capacity will increase, and the speed increases the bending capacity decreases.
- On stirrup bendings, switch the PROG. ON-OFF button to (Figure5: No:27) “ON” position and max. 9 different bending is adjusted at once and the bending can be done in the adjusted order.

- After the adjustment is finished, switch the MAN-AUTO button(Figure:5 No:28) to AUTO position and start to serial bending.
- In case of an emergency, machine can be stopped by pressing the 'emergency stop button2 on thecontrol panel. (Figure:5 No:30) When you start to bend machine will re-start from the latest adjusted programme.

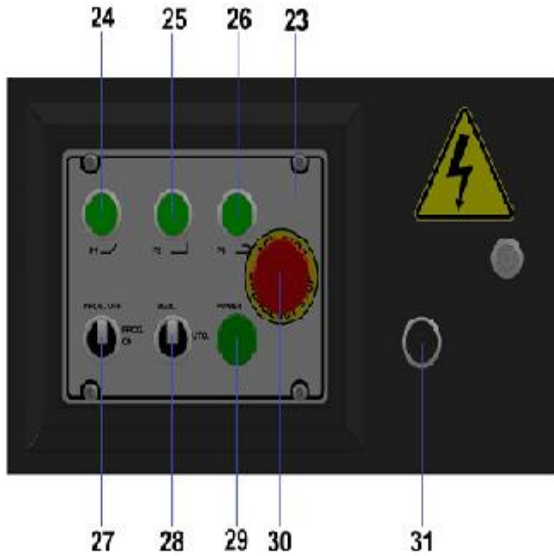

Figure 5: 220V Manual Machine Control Buttons

23	Control Panel	26	P3 Button	29	Power Lamp
24	P1 Button	27	Prog. On-Off Button	30	Emergency Stop
25	P2 Button	28	Man-Auto Button	31	Speed Controller

3.4.Operation of 380V Digital Machine:

- Place the suitable stirrup head for your rebar, the straight pin and the bending sleeve (Figure:1 No:10,11,12) to the related holes of the bending discs.
- Press to SET button on the control panel and than to PROG button and enter the intended data. Use the UP and DOWN arrows (Figure:6 No:39) and enter the intended angle degree to the angle indicator. (Figure:6 No:37) Press the right arrow and switch to unit indicator (Figure:6 No:38) and enter the intended unit. Once angle and unit data is entered press to down arrow and switch to SET line. Enter the data to set line and save it by pressing to PROG button. Maximum 9 value can be entered for each set line indicator.
- After the adjustment is finished switch to MAN-AUTO button (Figure:6 No:34) to AUTO position and start to serial bending.
- After the bending finishes due to various steel quality entered data and bended angle should differ, in case of such situations press to UP arrow for 15 seconds period. "100" or machine's factory setting "35" will appear on SET3 line's angle indicator. Use UP and DOWN arrows and change the angle as much as the bended angle difference and renew the calibration process by pressing the PROG button.
- In case of an emergency, machine can be stopped by pressing the 'emergency stop button2 on thecontrol panel. (Figure:5 No:30) When you start to bend machine will re-start from the latest adjusted programme.

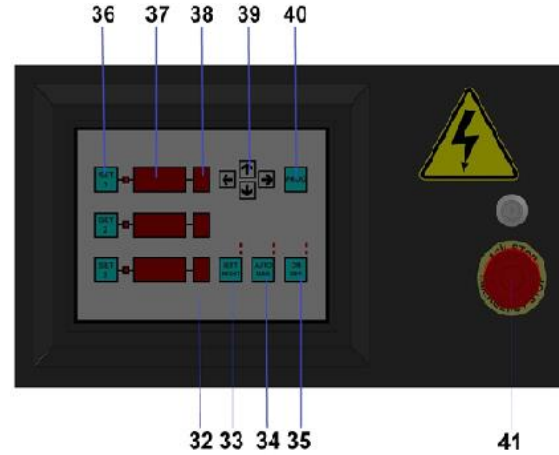

Figure 6: 380V Digital Machine Control Buttons

32	Control Panel	36	Set 1,2,3 Button	40	Prog. Button
33	Left-Right B Button	37	Angle Indicator	41	Emergency Stop
34	Man-Auto Button	38	Unit Indicator		
35	On-Off Button	39	Value Direction Arrows		

3.5. Operation of 220V Digital Machine:

- Place the suitable stirrup head for your rebar, the straight pin and the bending sleeve (Figure:1 No:10,11,12) to the related holes of the bending discs.
- Press to SET button on the control panel and than to PROG button and enter the intended data. Use the UP and DOWN arrows (Figure:7 No:49) and enter the intended angle degree to the angle indicator. (Figure:7 No:47) Press the right arrow and switch to unit indicator (Figure:7 No:48) and enter the intended unit. Once angle and unit data is entered press to down arrow and switch to SET line. Enter the data to set line and save it by pressing to PROG button. Maximum 9 value can be entered for each set line indicator.
- Adjust the machine's speed by the Speed Controller (Figure:7 No:52) Once the speed of the machine decreased, the bending disc's rotation speed will reduce and machine's power (bending capacity) will increase. And when the speed is increased the bending disc's rotation speed will increase and the machine's power (bending capacity) will decrease.
- As soon as the speed decreases the bending capacity will increase, and the speed increases the bending capacity decreases.
- After the adjustment is finished, switch the MAN-AUTO button(Figure:7 No:44) to AUTO position and start to serial bending.
- After the bending finishes due to various steel quality entered data and bended angle should differ, in case of such situations press to UP arrow for 15 seconds period. "100" or machine's factory setting "35" will appear on SET3 line's angle indicator. Use UP and DOWN arrows and change the angle as much as the bended angle difference and renew the calibration process by pressing the PROG button.
- In case of an emergency, machine can be stopped by pressing the 'emergency stop button2 on thecontrol panel. (Figure:7 No:51) When you start to bend machine will re-start from the latest adjusted programme.

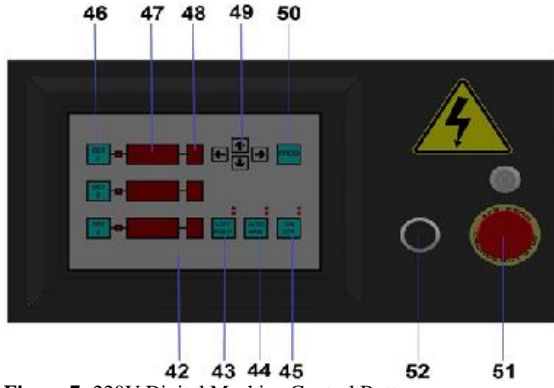

Figure 7: 220V Digital Machine Control Button



Figure 8: Machine Table and Ruler

42	Control Panel	46	Set 1,2,3 Button	50	Prog. Button
43	Left-Right Button	47	Angle Indicator	51	Emergency Stop
44	Man-Auto Button	48	Unit Indicator	52	Speed Controller
45	On-Off Button	49	Value Direction Arrows		

4. TECHNICAL DATA

	kw	hp	rpm	45 kg/mm ²	65 kg/mm ²	85 kg/mm ²	W*H	KG
Model				1 2 3	1 2 3	1 2		
MG20B	1,5	2	1	20 14 12	16 12 10	14 10	48*60*32	87

5. EQUIPMENT SUPPLIED WITH MACHINE

- Straight Pin : 1 ea
- Stirrup Head : 4 ea
- Bending Sleeve : 2 ea
- Switch Pin : 3 ea
- Machine Table : 1 ea (optional)
- Ruler : 1 ea (optional)

6. OPERATION OF MACHINE

6.1. Correct Positioning of Rebar On The Machine

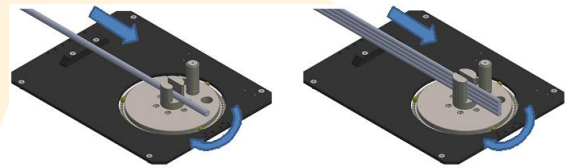

Correct Positioning of the rebar onto the machine by the help of bending Tools on single bending.

Correct Positioning of the rebar onto the machine by the help of bending Tools on multiple bending.

Figure 9: Correct Positioning of Rebar On The Machine

6.2. Incorrect Positioning of Rebar On The Machine

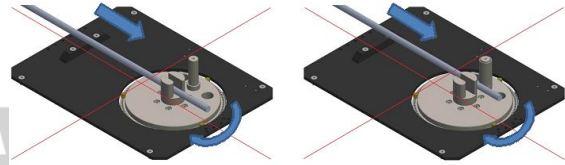

Incorrect Positioning of rebar onto the machine without using the bending sleeve

Incorrect Positioning of rebar onto the machine by mis-use of stirrup head.

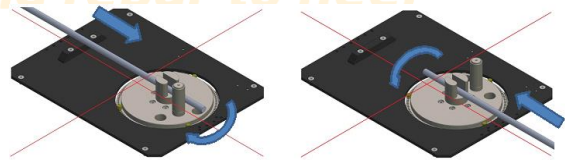

Incorrect Fixing of the rebar onto the machine according to the rotation of the bending disc.

Incorrect Fixing of the rebar onto the machine according to the rotation of the bending disc.

Figure 10: Incorrect Positioning of Rebar On The Machine

7. PROHIBITED USAGE ON THE MACHINE

- Machine mustn't be run when it is wet.
- No any bending must be made other than the measurements, dimensions and units stated on the capacity plate.
- Machine mustn't be run when the electricity Panel Cover.
- Electrical settings made in the factory shouldn't be changed.
- Machine shouldn't be operated without making grounding connection.
- Machine shouldn't be operated when any of its parts is dismantled.
- Machine should be operated by instructed operators.
- Machine never should be run unlubricated.
- Warning plates attached on the machine mustn't be removed
- No other parts should be mounted to the machine other than the ones manufactured by Gocmaksan.
- No bending should be made on the machine with bending apparatus which are deformed, cracked or have an increased hole diameter.
- No wrong bending should be made on the machine. (Figure:10)
- The rebar to be bent has to be placed correctly by the help of bending Tools (Figure:9)
- Machine should be cleaned by air.
- Main Electricity should be cut-off when machines electrical panel has to be open.
- When bending no one must stand in front of the machine and any one standing must be taken away.
- While the machine is running no any other construction material such as adze, hammer, meter, caliper etc. should be put between the bending apparatus other than the material that will be bent.
- During the multi bending number of Rebars stated on the capacity plate should be aligned one on top of the other and should be leaned to the retainer or bending rollers. No any other bending should be made other than this.

8. SCOPE OF WARRANTY

Manufacturer acknowledges warranty and liability provided that complying with the following conditions.

- Protectors found on the machine should be used.
- Warning signs should be taken into account.
- Machine shouldn't be operated without making grounding connection.
- Parts manufactured by GMS company should be used in case it is required to replace a broken part.
- Conditions indicated under the safety measures should be taken into account.
- Prohibited usage should be taken into account.
- Machine should be assembled in conformance with the assembly conditions.
- Machine should be transported in conformance with the handling conditions.
- Machine should be used by informed and authorized person.
- Measurements, dimensions and steel quality stated on the capacity plate should be taken into account.
- Machine should be used in conformance with its manufacturing purpose.

- Electricity connection should be made by competent technicians.
- Machine shouldn't be used with any of the parts on it disassembled.
- Motor of the machine shouldn't be changed.
- Maintenance of the machine should be made in conformance with the maintenance conditions.
- No Rebar higher than the indicated size should be bent with retainer (maximum 16 mm)
- Correct bending should be made with the machine. (Figure:9)

9. PROTECTORS TO BE USED WHEN WORKING WITH THE MACHINE

9.1. Protector apparel

- Helmet must be worn.
- Glasses must be worn.
- Boots with steel toe must be put on.
- Gloves must be worn.

The aforementioned protectors will be used. In case of not using these apparels there are risks of injury, cutting and trapping hands.

9.2. Work clothes

Inappropriate clothes against snatch or grip while working with the machine are listed below and in case of not conforming with this list might cause risk of injury.

Long hair, dress with long arms, bracelet, uniform with long skirt, any ornament leaning out.

10. TRANSPORTATION OF THE MACHINE

It is possible to carry the machine by manpower. Forklift has to be used only when the machine in a crate. In order to carry the machine in a crate machine's bottom shouldn't touch on the bottom of the crate, it is recommended to put skids between the machine and the crate. During the lifting operations experienced expert staff and subcontractors should be assigned.



WARNING!!!

Machine should be moved without any vibration. Machine shouldn't be run in a wet environment. If there are any lost or damaged parts during the handling, they should be reported to the manufacturer.

- When using the lifting and carrying equipments their maximum loading capacities should be taken into consideration.
- During the lifting equipment's center of gravity should be taken into consideration.



WARNING!!!

Warning signs on the carrier equipment should be taken into consideration.



Figure 11: Transportation of the Machine

11. CHECKS AND ADJUSTMENT

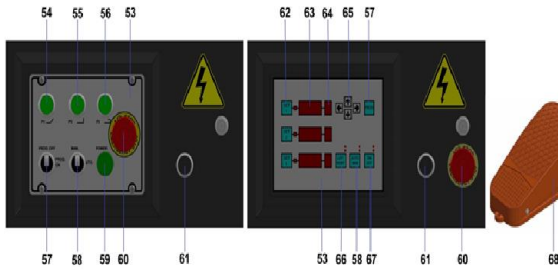

adjusted proper for the hook bending by moving the SWITCH pin on the angle adjustment holes around the bending disc. (As much as SWITCH pin closes toward SWITCH, the bending angle reduces, as much as it moves away from SWITCH, the bending angle increases).

One should press the P3 button on the control panel. On digital models, enter 180° pieces line “1” data to the angle indicator on SET1 line and press PROG button. After the adjustment procedure is completed, the stirrup head is inserted into the axles hub where is located on bending disc middle. Locate straight pin into one of the holes on the bending disc so as providing the suitable space due to the thickness of the rebar to be bent and place the one of proper bending bushes onto the pin. Then place the bending sleeves which is proper for the diameter of rebar to be bent onto the pin. Put one of other pins into one of the holes on the bending disc so as providing the suitable space due to the thickness of the rebar to be bent and place the one of proper bending bushes onto the pin. Place the rebar which you will bend onto the machine. Finally, in order to avoid injury possibly caused by moving of rebar after bending disc turns it back and the rebar returns, rebar should be located into the suitable stirrup head (channeled pin) because of safety conditions. it should be placed in front of the rebar and onto the bending bracket for security (FIGURE:9-14). Switch the machine to AUTO mode for serial bendings.

NOTE: When the machine is in the MAN position, as long as the foot pedal is pressed, the bending disc turns, and it stops, as the bending procedure is completed and the machine comes to the stand-by position. When the machine is in the AUTO position, the bending disc bends by pressing the foot pedal once and stops, when the machine comes to the stand-by position. In addition, when the machine is in the AUTO position again, the bending disc may stop as the foot pedal is pressed during the bending process. When the bending disc stops in such manner, it stops in the zero point in contrary to the bending direction by pressing the foot pedal continuously.

In order to change the adjustment, press the P1-P2-P3 buttons and in case of changing the adjustment, wait until the machine completes the bending process and stops, and press to the desired button in order to change the adjustment. Otherwise, when the buttons are pressed in order to change the adjustment, the adjustment change shall not be affective.

NO	BUTTON	FUNCTION
53	Control Panel	It is such a panel that keeps the control functions / electrical parts on it.
54	P1	Adjustment for bent bar bending.
55	P2	Adjustment for set-square bending
56	P3	Adjustment for hook bending
57	Prog. On - Off	Adjusts the stirrup mode on-off.
58	Man - Auto	Provides the manual and automatic control of machine.
59	Power	When ON button is pressed and power comes into the system, it lights on and shows that there is electricity in the system
60	Emergency Stop	Stops the machine by cutting the power off in case of emergency
61	Speed Controller	Adjusts the machine's speed.
62	SET 1-2-3	The lines where the bending data is entered. Has same functions with P1,P2,P3 Buttons.
63	Angle Line	Bending angle is adjusted in this line.
64	Unit Line	Bending unit is adjusted in this line.
65	Function Arrows	Ensures shifting between the functions and entering the numerical data.
66	Left - Right	Ensures the machine to rotate to the right or left direction
67	On - Off	Ensures the machine to be started or stopped
68	Foot Pedal	Enables the bending disc to rotate.

11.1 Thermal current adjustment field setting and engine protection switch;

The machine is adjusted by its manufacturer as 1,5 kW 1450 rpm 10,2 A for engine. It is not allowed user to readjust it. The motor protective switch is placed in the machine in order to avoid damaging the system by cutting the power off which comes into the system, when the excessive current comes into the system. In case that the switch is off, the switch is turned into the I position and is on. Otherwise, the engine protection switch should not be removed. (Figure:13)

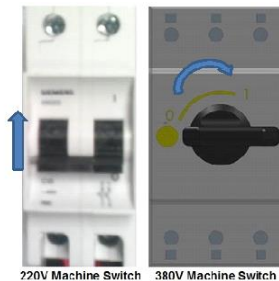

Figure 13: Motor Protection Switch

11.2. Hook Bending (P3)

Machine's turning direction is to be checked on MAN Mode. There are three SWITCH pins on the bending disc at the same length on Manual Bending Models. In order to make the hook bending on the machine, the correct bending angle should be

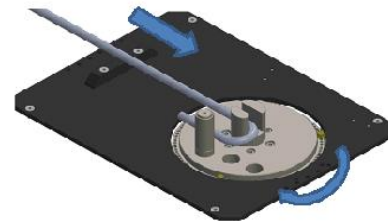

Figure 14: Hook Bending Setting

11.3. Set-Square Bending : (P2)

By pressing to the P2 button on the control panel, the adjustment should be made same as the adjustment method of hook bending.

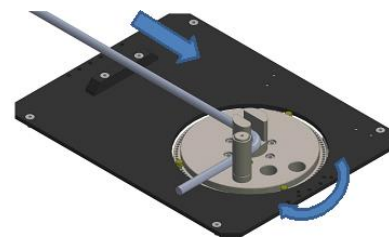

Figure 15: Set-Square Bending

11.4. Bent-Bar Bending (P1)

By pressing to the P1 button on the control panel, the adjustment should be made same as the adjustment method of hook bending

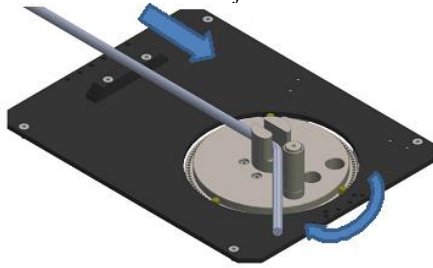
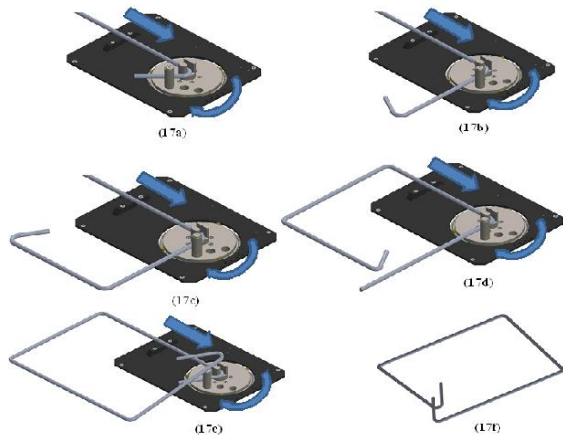

Figure 16: Bent-Bar Bending

11.5. Stirrup Bending:

On Manual models, press hook bending button (P3) on the control panel and the first adjustment should be made for the end bending of the rebar which will be stirrup by the adjustment unit in the hook section so as the bending angle shall be 135°. And then, the press setsquare bending position (P2) and the second bending adjustment should be made so as the bending angle shall be 90°. Later on, switch the PROG ON-OFF button to ON Position and in return, press once to P3, 3 times to P2 and again once to P3 button. In digital models, enter 1 to 135 cell of SET1 line, enter 3 to 90 cell of SET2, enter 1 to 135 cell of SET3 angle indicator. And press PROG button. After the adjustment procedures are completed (FIGURE: 17) , the bending order should be followed and stirrup bending procedures should be completed serially on AUTO mode.



12. MAINTENANCE AND LUBRICATION INSTRUCTIONS

It is important to make maintenance correctly in order to extend service life of the machine and to ensure safe bending. We suggest for each user to set up a secure system for control and maintenance of the machine. The following descriptions are given for reference. Number 140 and 90 gear oil is used in machine's gearbox.

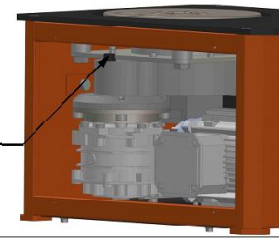

Figure 18: Machine Maintenance and Lubrication

FAULT 1: Machine isn't running.

	DESCRIPTION	SOLUTION
1	Missing phase might come to the electric supply system where the machine is connected	Check the phases
2	Emergency stop button might be pressed..	Check the button. If it is pressed open it by turning to the direction of the arrow on the button.
3	Motor protection switch might be blown.	Check the motor protection switch. If the switch is blown turn it to the position 1.
4	LEFT STOP RIGHT switch might be shut down.	. Check The LEFT STOP RIGHT Button, if it is on STOP mode turn it to LEFT or RIGHT Position
5	Electricity Panel Cover might be open or not closed completely	Check the Electricity Panel Cover
6	STOP SLOW FAST switch should be on STOP position	Check the switch and if it closed, switch it to SLOW or FAST position.

FAULT 2: Motor protection switch is blowing continuously

	DESCRIPTION	SOLUTION
1	Motor might be blown.	Check the motor.
2	If the machine is bending Rebar over its bending capacity	Check the bent Rebar according to the material type and measurements on the capacity plate.
3	Missing phase might come to the electric supply system.	Check the phases on the electricity network.
4	Transformer might be burnt.	Check the transformer.
5	There might be short circuit or wearing on the cables.	Check the cable and connections.

FAULT3: Machine is not running although the foot pedal is pressed.

	DESCRIPTION	SOLUTION
1	. The plug might be displaced	Check the plug.
2	Pedal switch might be out of order.	Check the SWITCH. Change them if they are out of order.
3	Contactors in the electricity network might be out of order	3. Check the contactors.

FAULT4: Emergency Stop is not running.

	DESCRIPTION	SOLUTION
1	Emergency stop contact might be out of order.	Change the emergency stop button.
2	Cable Connections might be unplugged.	Check the cable connections.









FAULT5: Machine is making noise

	DESCRIPTION	SOLUTION
1	Bearings might be broken down.	Check the bearings.
2	Motor's propeller cap might be rubbing	Check the propeller cap
3	Gears might be broken down.	Check the gears.
4	There might be no oil in the gearbox.	Check the gearbox oil.
5	Missing phase might come to the electric supply system which the machine is connected.	Check the phases in the network
6	Machine might having difficulty over its capacity.	Check the bent Rebar according to the capacity plate.
7	In the machines with electro-magnetic brake system, brake might not be working properly or the balata is broken down and scuffing .	Check if the brake and the balata.

FAULT6: Machine is leaking oil.

	DESCRIPTION	SOLUTION
1	1. Motor seal might be leaking oil.	Check the motor from the propeller side. If there is oil change the motor seal.
2	Gearbox connection bolts might be loose.	Check the connection bolts and if loose screw.

STICKERS USED ON THE MACHINE

	Manufacturer's Brand Cliche
	Manufacturer's Logo Cliche
MG 20 B	Machine's Model Name Sticker
	CE norm conformity sticker
	Plate of capacity and technical information of the machine
	Machine user's and maintenance manual sticker
	Kaldırma ve taşıma kancası yeri etiketi
	D5 Electricity panel warning sticker
	Grounding output sticker

13. SAFETY

- This symbol is put before the articles giving warning explanations in order to draw attention of the trained operator to important functions.
- € This symbol is put before the articles giving warning explanations in order to draw attention of the trained operator to electrical issues.
-  This symbol is put before the sentences in order to draw attention of the trained operator to the master instructions and directive regarding to handling or safety.

Bringing rebar to heel